

**ARIEL**

*The Modern Motor Cycle*

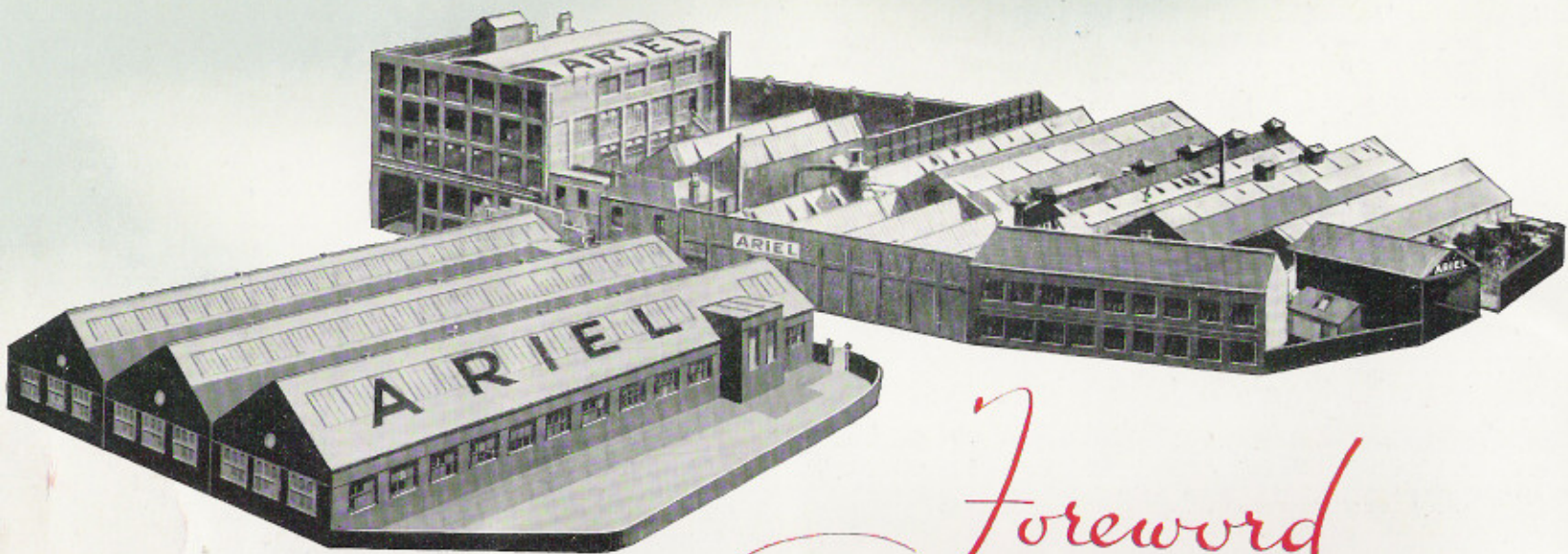



## Foreword

For more than 40 years it has been recognised that the name ARIEL is synonymous with the highest possible standards of motor cycling engineering. The wealth of experience and technical knowledge accumulated during this lengthy period has earned for us the proud title of "Leaders of Design," and we are confident that our 1939 Programme will still further enhance this enviable reputation.

It is hardly necessary to call attention to the big part played by this company in the popularising of the modern multi-cylinder motor cycle, and motor cyclists throughout the world will welcome the introduction of a 600 c.c. Square Four, incorporating all the well-known and tried features of the WORLD'S MOST WONDERFUL MOTOR CYCLE, the 1000 c.c. Square Four.

The introduction of the Ariel Patented Spring Frame, however, is undoubtedly the most outstanding feature in our Programme; indeed it is one of the most important developments in the history of motor cycling in

that all the disadvantages hitherto associated with spring frames have at last been eliminated. Full particulars will be found on page Twenty-four and it will be noticed that the spring frame can be fitted as an extra to all models excepting models OH and OG.

While no drastic alterations have been made to our single-cylinder machines many valuable improvements have been incorporated and the range has been augmented by the introduction of two very attractive Lightweights and a 500 c.c. Side Valve. We are pleased to record that the Red Hunters have once again demonstrated their superlative qualities by conspicuous performances in the 1938 "Scottish Six Days' Trial," the "International Six Days' Trial" and in hundreds of other important events at home and abroad.

We therefore offer from Ariel's modern factory a range of motor cycles unequalled for appearance, performance and design and we wish all Ariel owners, past and present, happy motoring for 1939.

**ARIEL MOTORS LIMITED, Selly Oak, BIRMINGHAM, 29, England**

Telephone: SELLY OAK 1331 (6 lines).

— Telegrams: "ARIEL, SELLY OAK." —

Codes: A.B.C. 5th Edition, BENTLEY'S and MARCONI

# Range & Prices for 1939

## SQUARE FOUR DE LUXE

1000 c.c. ... .. Model 4G ... .. £89 10 0

## SQUARE FOUR STANDARD

1000 c.c. ... .. Model 4H ... .. £83 10 0

## SQUARE FOUR

600 c.c. ... .. Model 4F ... .. £79 10 0

## RED HUNTER

500 c.c. ... .. Model VH ... .. £68 10 0

## RED HUNTER

350 c.c. ... .. Model NH ... .. £60 10 0

## RED HUNTER

250 c.c. ... .. Model OH ... .. £53 10 0

## O.H.V. DE LUXE

500 c.c. ... .. Model VG ... .. £63 10 0

## O.H.V. DE LUXE

350 c.c. ... .. Model NG ... .. £56 10 0

## O.H.V. DE LUXE

250 c.c. ... .. Model OG ... .. £48 10 0

## SIDE VALVE DE LUXE

600 c.c. ... .. Model VB ... .. £60 10 0

## SIDE VALVE STANDARD

500 c.c. ... .. Model VA ... .. £57 10 0

*Prices include Lucas Magdyno Electric Lighting and Electric Horn.*

*All prices are subject to alteration without notice.*





# General FOR ALL

**FRAME**—Cradle type with Aero quality steel tubes. All joints are brazed, ensuring ample strength and torsional stiffness. Built-in lugs for sidecar attachment except 250 c.c. models.

**FORKS**—Steel taper tube girders brazed to substantial bridges giving great rigidity. Progressive twin auxiliary springs (except 250 c.c. models) combined with central compression spring and friction damper of large area with finger control. Hand controlled steering damper.

**HANDLEBAR**—Patent rubber insulated mounting. Adjustable. Sports pattern grips. Handlebars 1in. at mounting tapering to  $\frac{7}{8}$ in. at grips on all models except models VA, VB, OH and OG.

**WHEELS**—Immensely strong, with butted spokes. Hubs mounted on large diameter taper roller bearings. Rear chain sprocket detachable. Instantly detachable rear wheel can be fitted to any model at an extra charge. (Standard on model 4G).

**BRAKES**—Powerful and progressive, with finger adjustment. Wide shoes with additional wedge type fulcrum adjustment to rear, and self centralizing bronze cam bearing to front. Millenite brake drums. Sizes: 250 c.c. models  $6\frac{1}{2}$ in. front; 7in. rear. All other models 7in. front and rear.

**STANDS**—Forged steel girder "spring-up" rear, and strong tubular front. Lifting handle on rear mudguard.

**FOOTRESTS**—Adjustable over wide range. Special lugs are provided on chain stays for pillion footrests.

page two

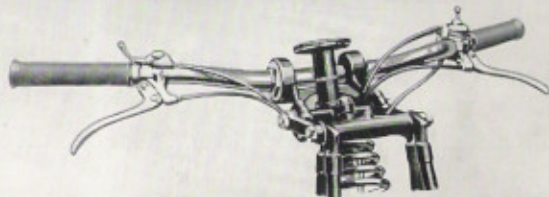



# Specification MODELS

**CONTROLS**—Twist grip throttle control. Hand-controlled clutch. All other controls adjustable to suit individual requirements.

**SADDLE**—Aero elastic soft top. Adjustable.

**INSTRUMENT PANEL**—(Except 250 c.c. models). Rubber insulated tank mounting. The panel incorporates the car type oil pressure gauge and the quick release cam-operated filler cap. Provision is also made for gearbox-driven speedometer and clock (see Extras). The panel light which illuminates all instruments is detachable for use as an inspection lamp.

**IGNITION AND LIGHTING**—Lucas 6-volt Magdyno equipment with large 8in. head lamp, handlebar-controlled dimmer, tail light and compensated voltage control. The battery is mounted on a strong steel platform under the saddle, is easily accessible and is entirely free from vibration.

**HORN**—Electric, mounted on special bracket in protected position in front of the engine.

**EQUIPMENT**—Large all-steel tool box with central screw fastening and water excluding rubber beading. Complete kit of tools, grease gun and tyre inflator.

**FINISH**—Three coats of finest black enamel on cosletized (anti-rust) base. All bright parts heavily chromium plated. Tanks are superbly finished according to specification. The "ARIEL" permanent enamel name badges on the tank and on the rear mudguard, give the whole machine an air of great distinction.

page three

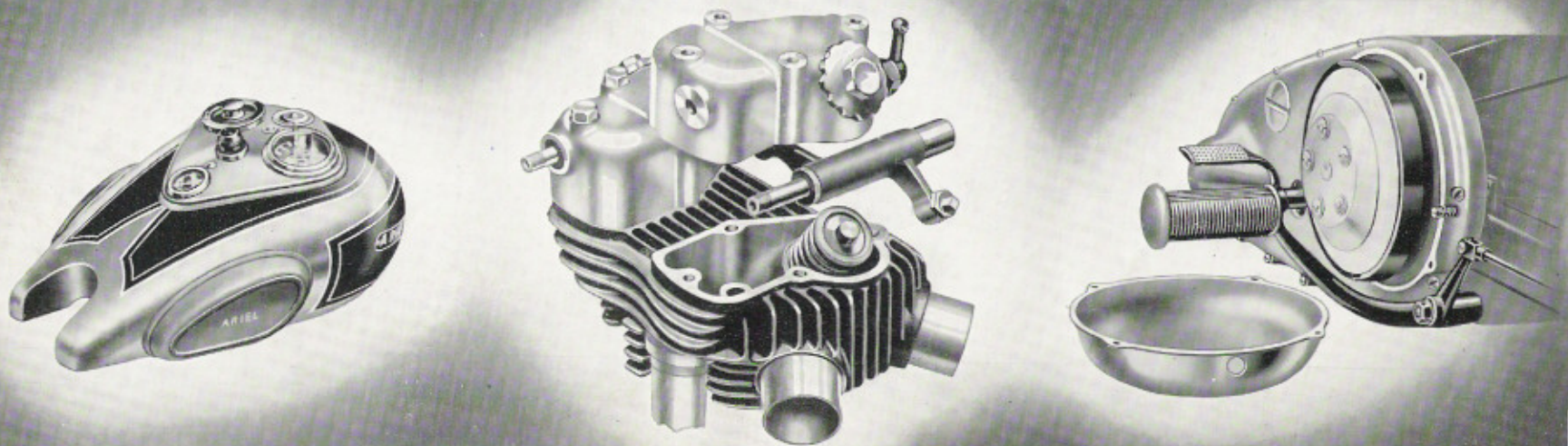



*The*  
**SQUARE FOUR DE LUXE**

**1000cc. MODEL 4G £89-10**

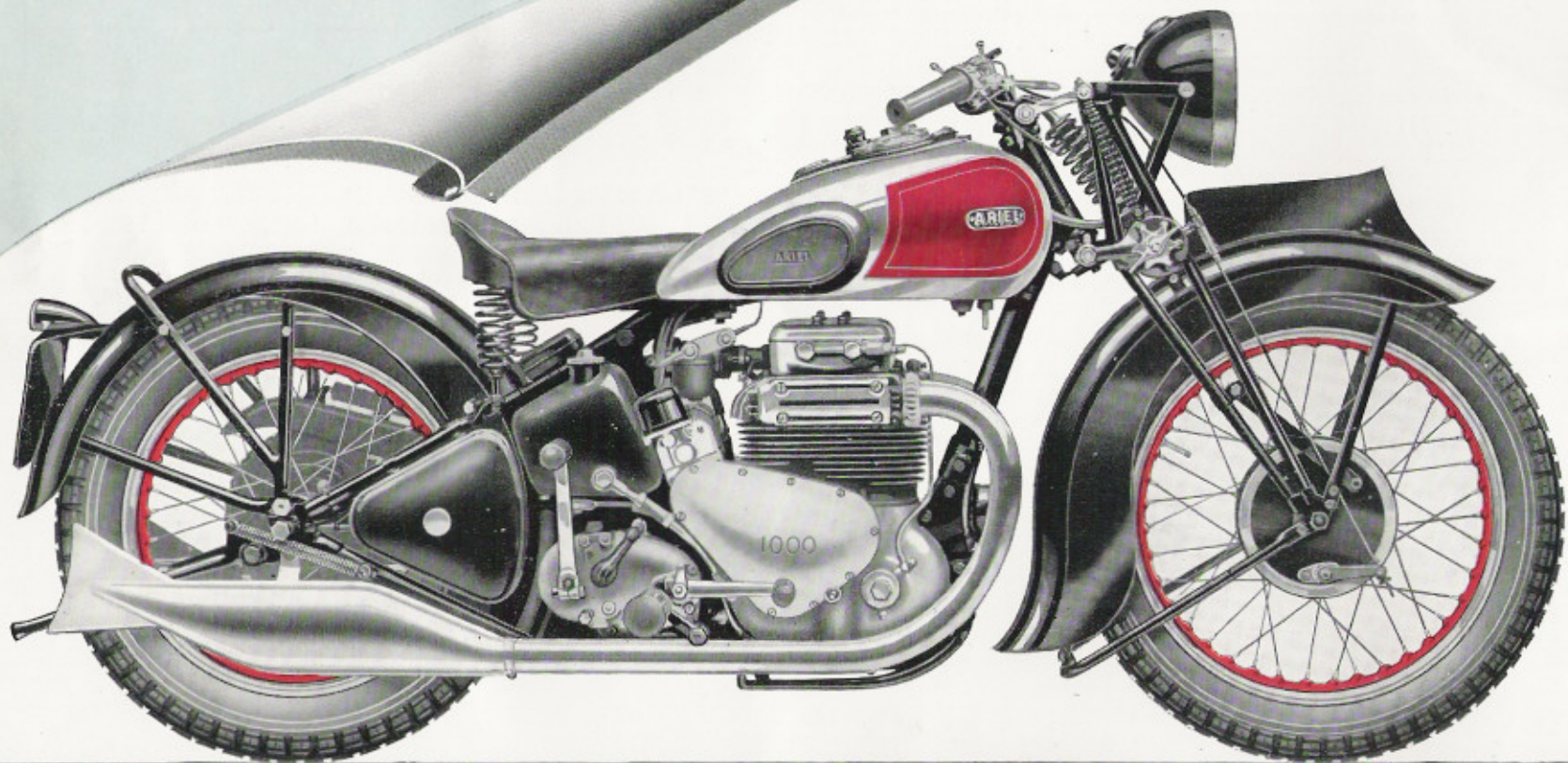



# The **SQUARE FOUR DE LUXE 1000<sub>cc</sub> MODEL 4G**

**ENGINE**—65 x 75 mm. (997 c.c.) Four Cylinders cast en bloc in square formation. Detachable cylinder head with integral radial induction manifold and detachable exhaust manifolds. Totally enclosed overhead valves operated by short push rods. Camshaft and magdyno driven by automatically tensioned roller chain. The twin crankshafts are mounted on substantial bearings and coupled by hardened and ground gears immersed in oil in a separate compartment adjacent to the crankcase. Both crankshafts are substantial high tensile alloy-steel drop forgings, carrying central flywheels, bobweighted and accurately balanced. Light rigid con-rods with split lined big ends.

**LUBRICATION**—Dry sump system in conjunction with a separate oil tank holding  $\frac{3}{4}$ -gallon. Double plunger pump, one of which forces lubrication through all engine bearings at a nominal pressure of 60 lbs. per square inch. The valve gear is lubricated by pressure, requiring no attention. The scavenging pump returns oil which drains to the bottom of the crankcase by gravity through a star shaped filter back to the oil tank. The oil tank is provided with a large gauze on the delivery side and a separate large capacity vent.

**CARBURETTER**—Fully automatic.

**IGNITION**—Magdyno with self contained gear driven distributor. 14 mm. sparking plugs. Cut-out switch in instrument panel.

**GEARBOX**—Four-speed. Foot control. Clutch lever enclosed in rubber moulding.

**SPEEDOMETER**—Smith 100 m.p.h. trip speedometer, tank mounted, gearbox drive, will be fitted at extra (see page 28) unless otherwise ordered. Fork mounted, internal front wheel drive optional.

**TRANSMISSION**—Engine shaft 3-cam shock absorber. Polished aluminium oil bath chain case and Ariel outside clutch of large dimensions. Rear chain fully protected and automatically lubricated.

**EXHAUST SYSTEM**—Interconnected pipes exhausting into single silencer on offside of machine. Two separate exhaust pipes and silencers optional.

**WHEELS**—Dunlop Speed Universal tyres 4.00 x 18 rear ; 3.25 x 19 front. Chromium rims, Red centres (Black centres optional), Chromium brake plates. Detachable rear wheel.

**MUDGUARDS**—Robust ribbed section steel guards, fully valanced. Tail of rear guard hinged to facilitate wheel removal.

**PROP STAND**—Fitted to offside of machine in addition to two normal stands.

**TANK**—All steel saddle type with instrument panel.  $3\frac{3}{4}$ -gallon capacity. Superbly finished in Chromium and Red, lined Gold (Chromium and Black optional).

*The statue of Colonel Light, Adelaide, South Australia,  
The South Australian Traffic Police always use Ariels.*





*The*  
**SQUARE FOUR**

**600 cc. MODEL 4F £79.10**

**1000 cc. MODEL 4H £83.10**

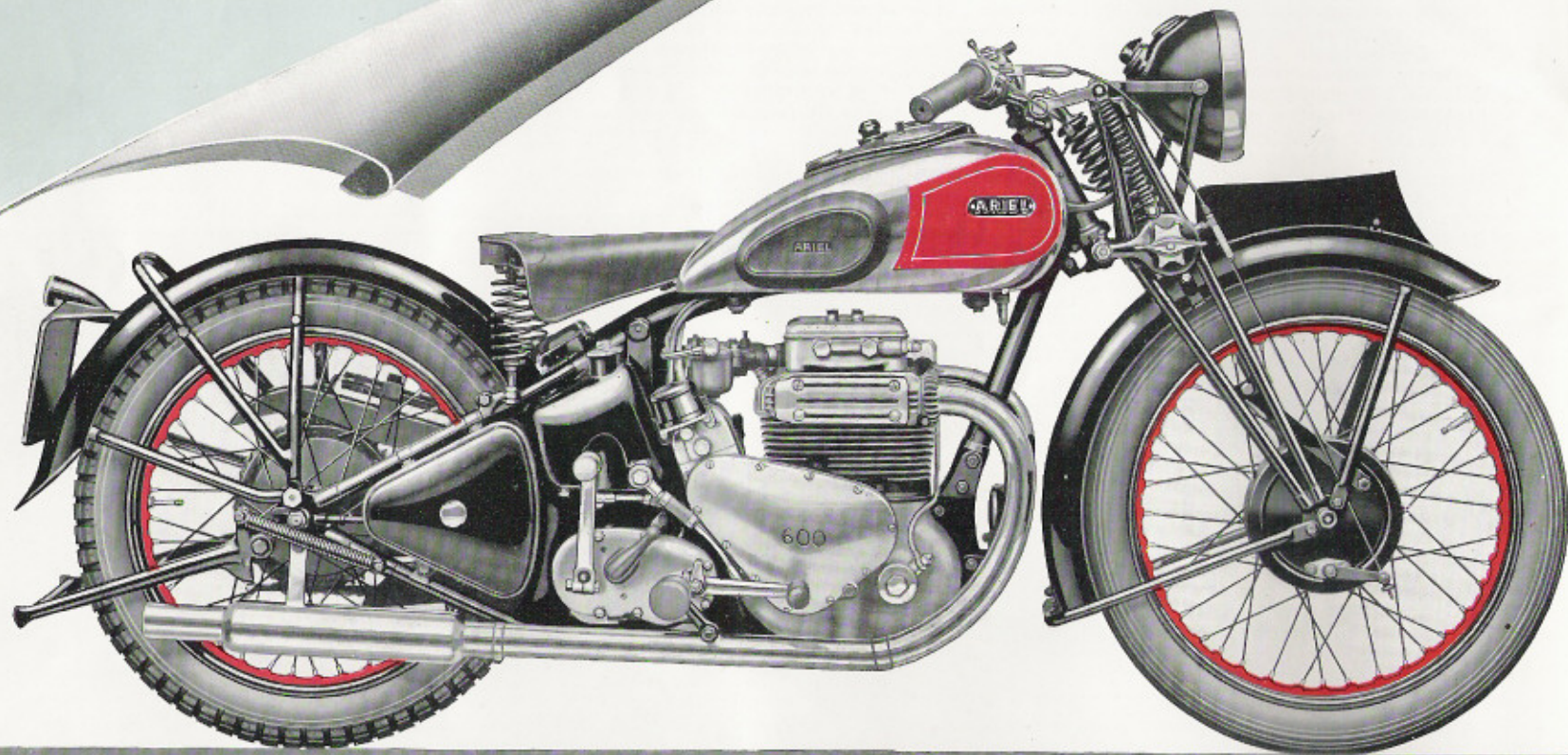



# The **SQUARE FOUR** 600 c.c. MODEL 4F 1000 c.c. MODEL 4H

**ENGINE**—4F : 50.4 x 75 mm. (599 c.c.) 4H : 65 x 75 mm. (997 c.c.) Four Cylinders cast *en bloc* in square formation. Detachable cylinder head with integral radial induction manifold and detachable exhaust manifolds. Totally enclosed overhead valves operated by short push rods. Camshaft and magdyno driven by automatically tensioned roller chain. The twin crankshafts are mounted on substantial bearings and coupled by hardened and ground gears immersed in oil in a separate compartment adjacent to the crankcase. Both crankshafts are substantial high tensile alloy-steel drop forgings, carrying central flywheels, bobweighted and accurately balanced. Light rigid con-rods with split lined big ends.

**LUBRICATION**—Dry sump system in conjunction with a separate oil tank holding  $\frac{3}{4}$ -gallon. Double plunger pump, one of which forces lubrication through all engine bearings at a nominal pressure of 60 lbs. per square inch. The valve gear is lubricated by pressure, requiring no attention. The scavenging pump returns oil which drains to the bottom of the crankcase by gravity through a star shaped filter back to the oil tank. The oil tank is provided with a large gauze on the delivery side and a separate large capacity vent.

**CARBURETTER**—Fully automatic.

**IGNITION**—Magdyno with self contained gear driven distributor. 14 mm. sparking plugs. Cut-out switch in instrument panel.

**GEARBOX**—Four-speed. Foot control. Clutch lever enclosed in rubber moulding.

**SPEEDOMETER**—Smith 100 m.p.h. trip speedometer, tank mounted, gearbox drive, will be fitted at extra (see page 28) unless otherwise ordered. Fork mounted, internal front wheel drive optional.

**TRANSMISSION**—Engine shaft 3-cam shock absorber. Polished aluminium oil bath chain case and Ariel outside clutch of large dimensions. Rear chain fully protected and automatically lubricated.

**EXHAUST SYSTEM**—Interconnected pipes exhausting into single silencer on offside of machine. Two separate exhaust pipes and silencers optional.

**WHEELS**—Dunlop tyres, 3.25 x 19 Speed Universal rear ; 3.00 x 20 ribbed front.

**MUDGUARDS**—Robust ribbed section steel guards, as illustrated. Tail of rear guard hinged to facilitate wheel removal.

**TANK**—All steel saddle type with instrument panel.  $3\frac{1}{2}$ -gallon capacity. Superbly finished in Chromium and Red, lined Gold. (Chromium and Black optional).

Willingdon Air Station, New Delhi, India

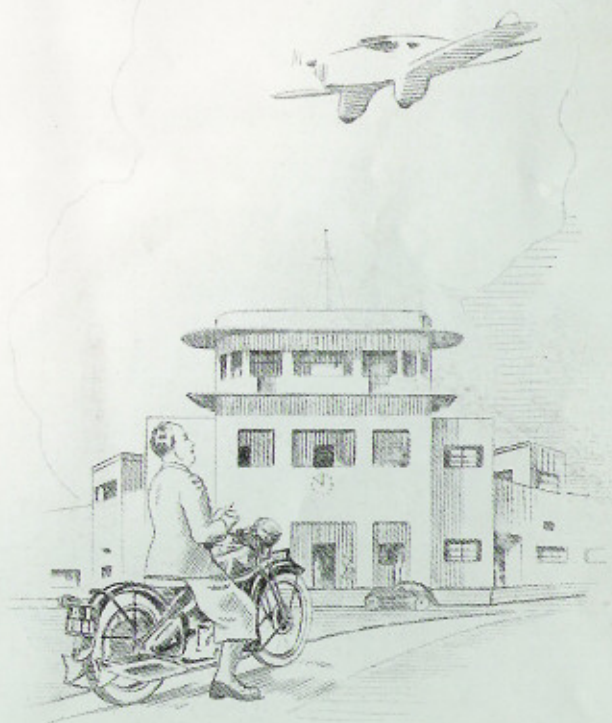



*The*  
**RED HUNTER**  
500.c.c. MODEL VH £68.10

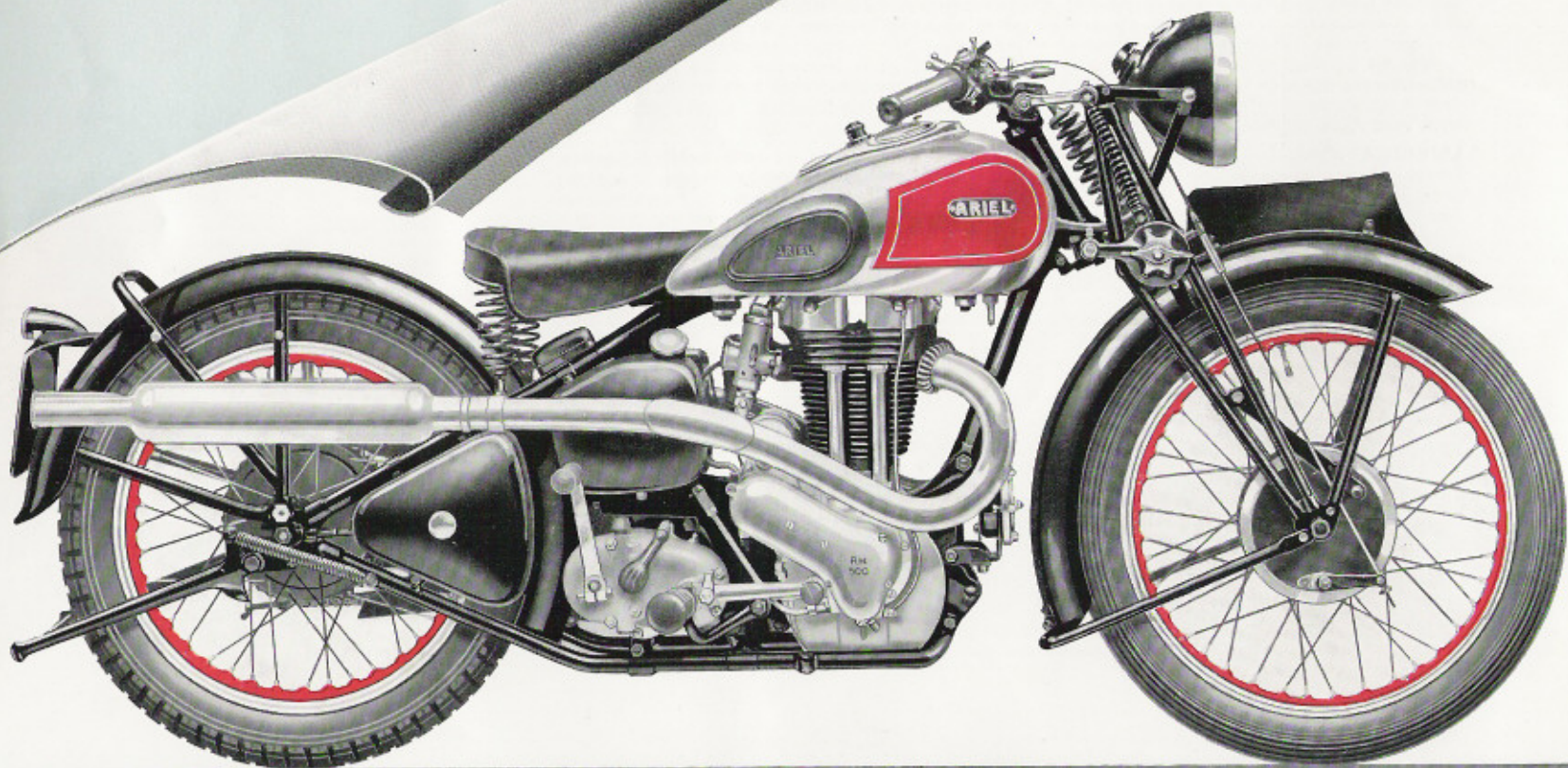



# The RED HUNTER 500.c.c. MODEL VH

**ENGINE**—81.8 x 95 mm. (497 c.c.) O.H.V. Two port (VH2) or Single port (VH 1) optional. Specially bench tested and capable of being tuned to speeds exceeding 100 m.p.h. Completely enclosed valve and rocker gear automatically lubricated under pressure. Ground and highly polished ports. 14 mm. sparking plug. Extremely rigid crankcase designed for maximum speeds and efficiency. Polished high tensile steel flywheels. Large diameter mainshafts mounted on two heavy duty roller bearings and one ball bearing. Extra large double roller bearing big-end with duralumin cage. Light and rigid nickel-chrome steel con-rod polished all over. Special light pressure piston rings. A medium compression piston is fitted as standard. A high compression piston giving a ratio of 7.5 to 1 (suitable for 50/50 Petrol/Benzole only) can be fitted to special order, without extra charge.

**LUBRICATION**—Dry sump system employing dual plunger pumps and  $\frac{3}{4}$ -gallon capacity separate oil tank. Patent oil purifier incorporated in Flywheels.

**CARBURETTER**—Large bore, down-draught Amal. Petroflex supply pipe.

**GEARBOX**—Four-speed. Foot control. Clutch lever enclosed in rubber moulding.

**SPEEDOMETER**—Smith 100 m.p.h. trip speedometer, tank mounted, gearbox drive, will be fitted at extra (see page 28) unless otherwise ordered. Fork mounted, internal front wheel drive optional.

**TRANSMISSION**—Engine shaft shock absorber. Polished aluminium oil bath chain case and Ariel outside clutch of large dimensions. Rear chain fully protected and automatically lubricated.

**EXHAUST SYSTEM**—Two-port : Silencers : Large capacity, as illustrated.  
Pipes : Upswept with leg guards or low level to special order.  
Single-port : Silencer : As Model VG.  
Pipe : Upswept with leg guard or low level to special order.

**WHEELS**—Dunlop tyres, 3.25 x 19 Speed Universal rear ; 3.00 x 20 ribbed front. Chromium brake plates. Chromium rims. Red centres.

**MUDGUARDS**—Robust ribbed section steel guards, as illustrated. Tail of rear guard hinged to facilitate wheel removal.

**TANK**—All-steel saddle type, with instrument panel.  $\frac{3}{4}$ -gallon capacity. Superbly finished Chromium and Red, lined Gold.

*Copenhagen, Denmark*





*The*  
**RED HUNTER**  
350 c.c. MODEL NH £60.10

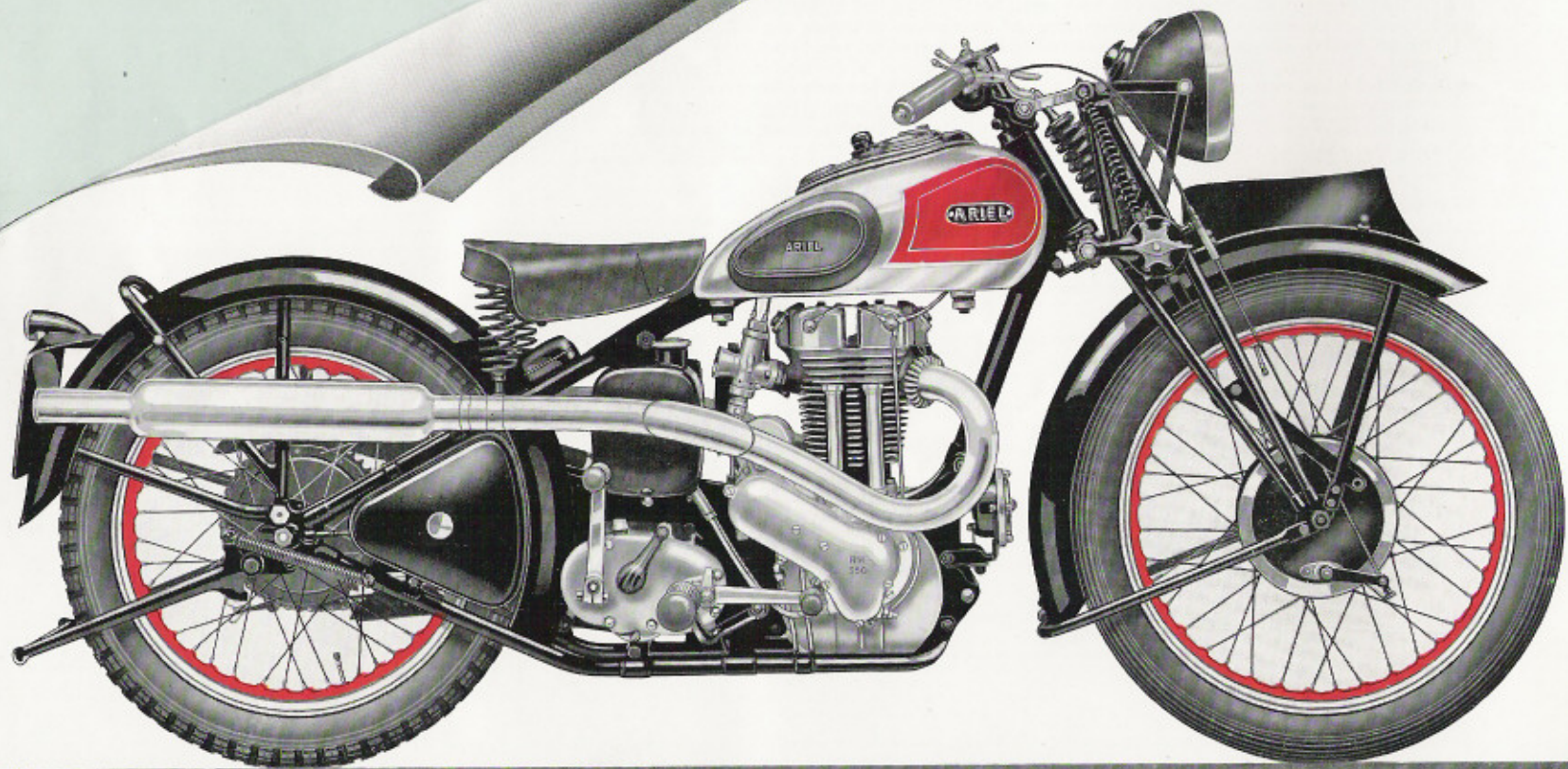



# The RED HUNTER 350 c.c. MODEL NH

**ENGINE**—72 x 85 mm. (347 c.c.) O.H.V. Two-port (NH 2) or Single-port (NH 1) optional. Specially bench-tested and capable of being tuned to speeds exceeding 80 m.p.h. Completely enclosed valve and rocker gear automatically lubricated under pressure. Ground and highly polished ports. 14 mm. sparking plug. Heavily ribbed crankcase. Polished forged steel flywheels. Ball bearings on both sides of mainshaft. Double roller bearing big-end. Special polished alloy steel con-rod. A medium compression piston is fitted as standard. A high compression piston, giving a ratio of 7.5 to 1 (suitable for 50/50 Petrol/Benzole only) can be fitted to special order, without extra charge.

**LUBRICATION**—Dry sump system, employing dual plunger pumps and  $\frac{1}{2}$ -gallon capacity separate oil tank. Patent oil purifier incorporated in Flywheels.

**CARBURETTER**—Large bore, down-draught Amal. Petroflex supply pipe.

**GEARBOX**—Four-speed. Foot control. Clutch lever enclosed in rubber moulding.

**SPEEDOMETER**—Smith 80 m.p.h. trip speedometer, tank mounted, gearbox drive, will be fitted at extra (see page 28) unless otherwise ordered. Fork mounted, internal front wheel drive optional.

**TRANSMISSION**—Engine shaft shock absorber. Polished aluminium oil bath chain case and Ariel outside clutch of large dimensions. Rear chain fully protected and automatically lubricated.

**EXHAUST SYSTEM**—Two-port      Silencers : Large capacity, as illustrated.  
   or Pipes :      Upswept with leg guard(s) or low level to special  
   Single-port :      order.

**WHEELS**—Dunlop tyres 3.25 x 19 Speed Universal rear ; 3.00 x 20 ribbed front. Chromium brake plates. Chromium rims. Red centres.

**MUDGUARDS**—Robust ribbed section steel guards, as illustrated. Tail of rear guard hinged to facilitate wheel removal.

**TANK**—All-steel saddle type, with instrument panel.  $2\frac{1}{2}$ -gallon capacity. Superbly finished Chromium and Red, lined Gold.

*The Capitol, Washington, U.S.A.*

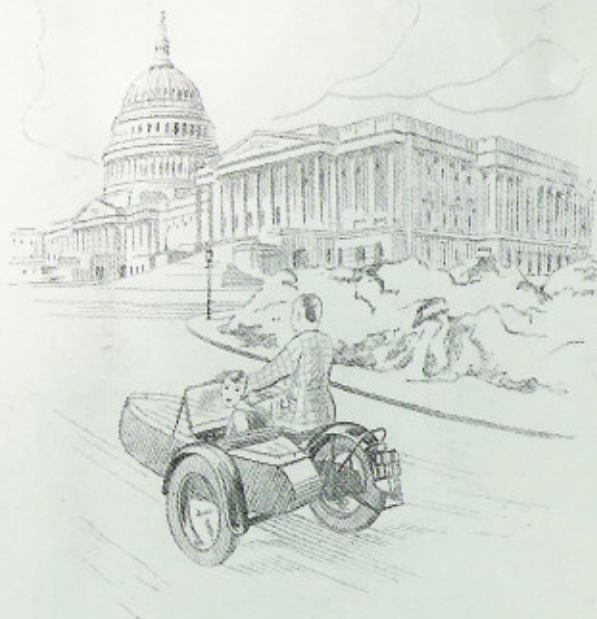



*The*  
**RED HUNTER**  
250 c.c. MODEL OH £53.10

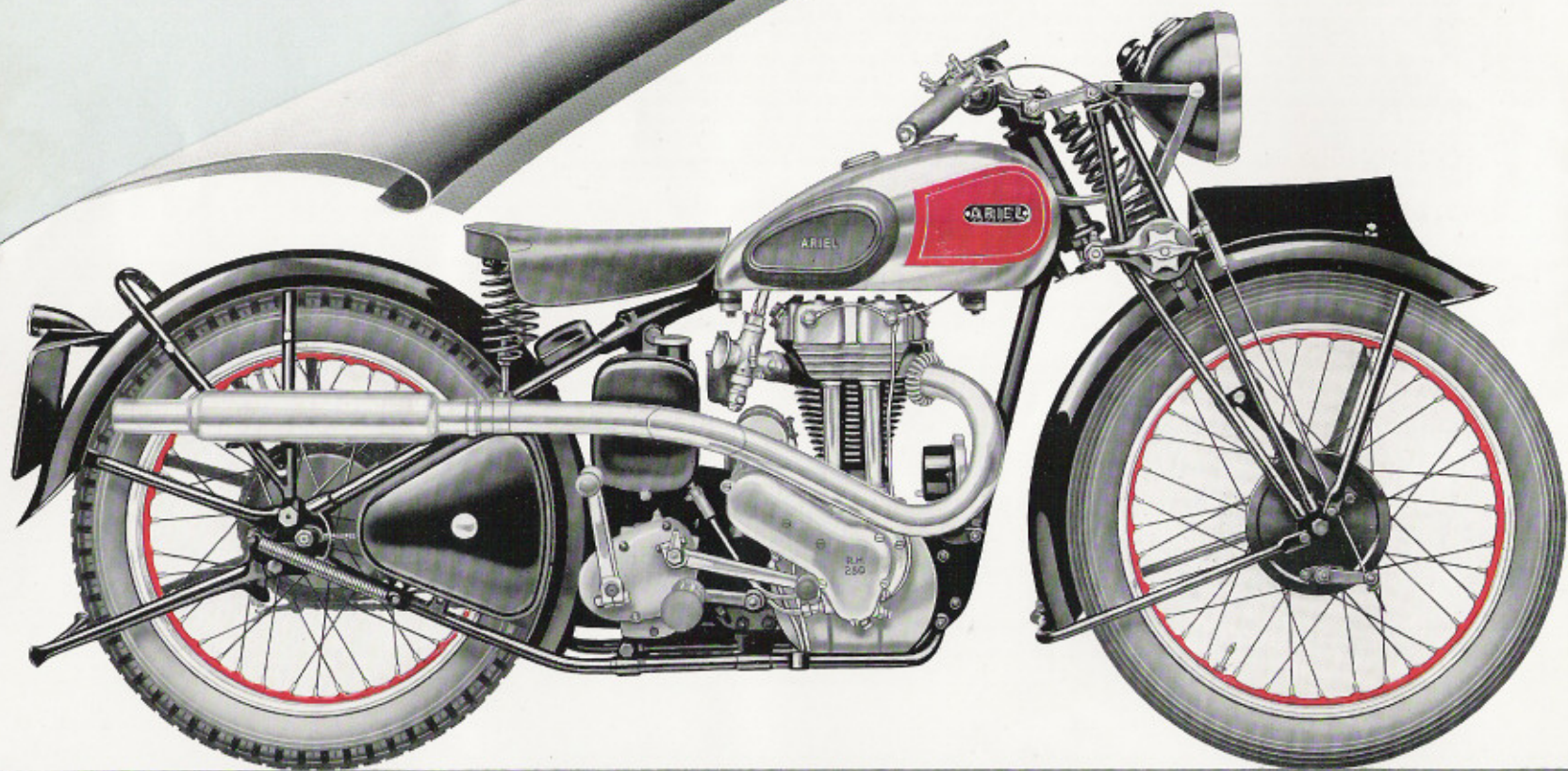



# The RED HUNTER 250<sub>c.c.</sub> MODEL OH

**ENGINE**—61 x 85 mm. (249 c.c.) O.H.V. Single-port (Two-port 30/- extra). Specially bench-tested and capable of being tuned to speeds exceeding 70 m.p.h. Completely enclosed valve and rocker gear automatically lubricated under pressure. Ground and highly polished ports. 14 mm. sparking plug. Heavily ribbed crankcase. Polished forged steel flywheels. Ball bearings on both sides of mainshaft. Double roller bearing big-end. Special polished alloy steel con-rod. Special aluminium alloy piston. 7 to 1 compression.

**LUBRICATION**—Dry sump system, employing dual plunger pumps and  $\frac{1}{2}$ -gallon capacity separate oil tank. Patent oil purifier incorporated in Flywheels.

**CARBURETTER**—Large bore, down-draught Amal. Petroflex supply pipe.

**GEARBOX**—Four-speed. Foot control. Internal clutch operating lever.

**SPEEDOMETER**—Smith 80 m.p.h. trip speedometer will be fitted at extra (see page 28) unless otherwise ordered. Fork mounted, internal front wheel drive only.

**TRANSMISSION**—Engine shaft shock absorber. Polished aluminium oil bath chain case with plug for clutch adjustment. Rear chain fully protected and automatically lubricated.

**EXHAUST SYSTEM**—Single-port with round spiral baffle silencer. Unswept pipe with leg guard or low level pipe to special order.

**WHEELS**—Dunlop tyres, 3.25 x 19 Universal Speed rear; 3.00 x 20 ribbed front. Chromium brake plates. Chromium rims. Red centres.

**MUDGUARDS**—Robust ribbed section steel guards, as illustrated. Tail of rear guard hinged to facilitate wheel removal.

**TANK**—All steel saddle type without instrument panel. Centrally disposed quick release filler cap and oil gauge.  $2\frac{1}{2}$ -gallon capacity. Superbly finished Chromium and Red, lined Gold.

*The Old Weigh House, Amsterdam, Holland.*





*The*  
**O.H.V. DE LUXE**  
**500 c.c. MODEL VG £63.10**

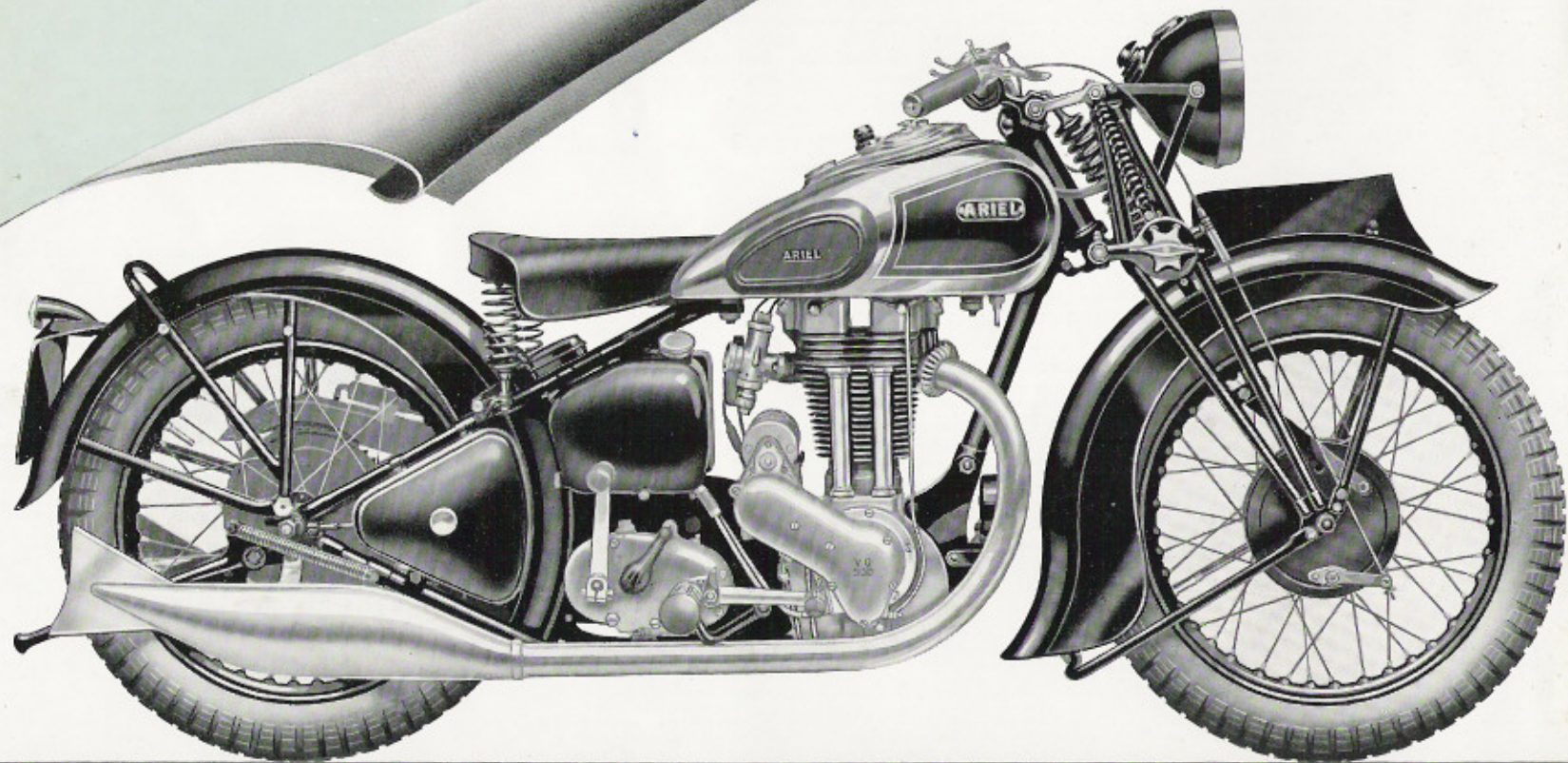



# The O.H.V. DE LUXE 500<sub>cc.</sub> MODEL VG

**ENGINE**—81.8 x 95 mm. (497 c.c.). High efficiency engine. Completely enclosed valve and rocker gear automatically lubricated under pressure. Ball bearings on both sides of mainshaft. Double roller bearing big-end. High tensile steel connecting rod. Aluminium alloy piston, 6 to 1 compression.

**LUBRICATION**—Dry sump system, employing dual plunger pumps and  $\frac{3}{4}$ -gallon capacity separate oil tank. Patent oil purifier incorporated in Flywheels.

**CARBURETTER**—Down-draught Amal.

**GEARBOX**—Four-speed. Foot control. Clutch lever enclosed in rubber moulding.

**SPEEDOMETER**—Smith 80 m.p.h. trip speedometer, tank mounted, gearbox drive, will be fitted at extra (see page 28) unless otherwise ordered. Fork mounted, internal front wheel drive optional.

**TRANSMISSION**—Engine shaft shock absorber. Polished aluminium oil bath chain case and Ariel outside clutch of large dimensions. Rear chain fully protected and automatically lubricated.

**EXHAUST SYSTEM**—Two-port, with streamlined silencers.

**WHEELS**—Dunlop Universal tyres, 3.25 x 19.

**MUDGUARDS**—Robust ribbed section steel guards, fully valanced, as illustrated. Tail of rear guard hinged to facilitate wheel removal.

**TANK**—All-steel saddle type, with instrument panel.  $3\frac{1}{2}$ -gallon capacity. Superbly finished Chromium and Black, lined Gold.

*The Royal Palace, Oslo, Norway.*





# The O.H.V. DE LUXE 500<sub>c.c.</sub> MODEL VG

**ENGINE**—81.8 x 95 mm. (497 c.c.). High efficiency engine. Completely enclosed valve and rocker gear automatically lubricated under pressure. Ball bearings on both sides of mainshaft. Double roller bearing big-end. High tensile steel connecting rod. Aluminium alloy piston, 6 to 1 compression.

**LUBRICATION**—Dry sump system, employing dual plunger pumps and  $\frac{1}{2}$ -gallon capacity separate oil tank. Patent oil purifier incorporated in Flywheels.

**CARBURETTER**—Down-draught Amal.

**GEARBOX**—Four-speed. Foot control. Clutch lever enclosed in rubber moulding.

**SPEEDOMETER**—Smith 80 m.p.h. trip speedometer, tank mounted, gearbox drive, will be fitted at extra (see page 28) unless otherwise ordered. Fork mounted, internal front wheel drive optional.

**TRANSMISSION**—Engine shaft shock absorber. Polished aluminium oil bath chain case and Ariel outside clutch of large dimensions. Rear chain fully protected and automatically lubricated.

**EXHAUST SYSTEM**—Two-port, with streamlined silencers.

**WHEELS**—Dunlop Universal tyres, 3.25 x 19.

**MUDGUARDS**—Robust ribbed section steel guards, fully valanced, as illustrated. Tail of rear guard hinged to facilitate wheel removal.

**TANK**—All-steel saddle type, with instrument panel.  $3\frac{1}{2}$ -gallon capacity. Superbly finished Chromium and Black, lined Gold.

*The Royal Palace, Oslo, Norway.*





*The*  
**O.H.V. DE LUXE**  
**350 c.c. MODEL NG £56.10**

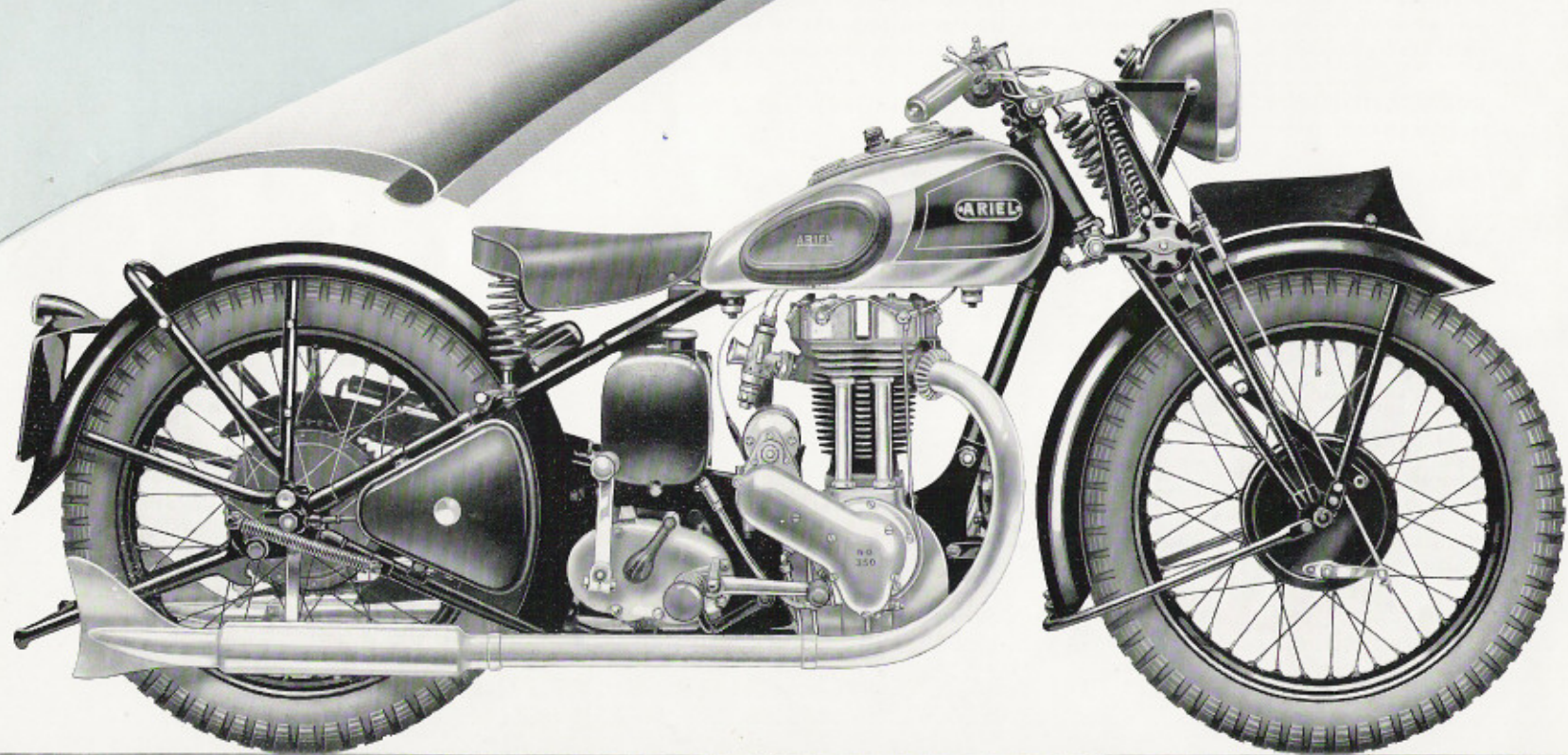



# The O.H.V. DE LUXE 350 cc. MODEL NG

**ENGINE**—72 x 85 mm. (347 c.c.). High efficiency engine. Completely enclosed valve and rocker gear automatically lubricated under pressure. Ball bearings on both sides of mainshaft. Double roller bearing big-end. High tensile steel connecting rod. Aluminium alloy piston.

**LUBRICATION**—Dry sump system, employing dual plunger pumps and  $\frac{1}{2}$ -gallon capacity separate oil tank. Patent oil purifier incorporated in Flywheels.

**CARBURETTER**—Down-draught Amal.

**GEARBOX**—Four-speed. Foot control. Clutch lever enclosed in rubber moulding.

**SPEEDOMETER**—Smith 80 m.p.h. trip speedometer, tank mounted, gearbox drive, will be fitted at extra (see page 28) unless otherwise ordered. Fork mounted, internal front wheel drive optional.

**TRANSMISSION**—Engine shaft shock absorber. Polished aluminium oil bath chain case and Ariel outside clutch of large dimensions. Rear chain fully protected and automatically lubricated.

**EXHAUST SYSTEM**—Two-port with round spiral baffle silencers. (Detachable fishtails optional).

**WHEELS**—Dunlop Universal tyres 3.25 x 19.

**MUDGUARDS**—Robust ribbed section steel guards, as illustrated. Tail of rear guard hinged to facilitate wheel removal.

**TANK**—All-steel saddle type, with instrument panel.  $2\frac{1}{2}$ -gallon capacity. Superbly finished Chromium and Black, lined Gold.

*Parliament Buildings Wellington, New Zealand*





# The **O.H.V. DE LUXE 350.c.c. MODEL NG**

**ENGINE**—72 x 85 mm. (347 c.c.). High efficiency engine. Completely enclosed valve and rocker gear automatically lubricated under pressure. Ball bearings on both sides of mainshaft. Double roller bearing big-end. High tensile steel connecting rod. Aluminium alloy piston.

**LUBRICATION**—Dry sump system, employing dual plunger pumps and  $\frac{1}{2}$ -gallon capacity separate oil tank. Patent oil purifier incorporated in Flywheels.

**CARBURETTER**—Down-draught Amal.

**GEARBOX**—Four-speed. Foot control. Clutch lever enclosed in rubber moulding.

**SPEEDOMETER**—Smith 80 m.p.h. trip speedometer, tank mounted, gearbox drive, will be fitted at extra (see page 28) unless otherwise ordered. Fork mounted, internal front wheel drive optional.

**TRANSMISSION**—Engine shaft shock absorber. Polished aluminium oil bath chain case and Ariel outside clutch of large dimensions. Rear chain fully protected and automatically lubricated.

**EXHAUST SYSTEM**—Two-port with round spiral baffle silencers. (Detachable fishtails optional).

**WHEELS**—Dunlop Universal tyres 3.25 x 19.

**MUDGUARDS**—Robust ribbed section steel guards, as illustrated. Tail of rear guard hinged to facilitate wheel removal.

**TANK**—All-steel saddle type, with instrument panel.  $2\frac{1}{2}$ -gallon capacity. Superbly finished Chromium and Black, lined Gold.

*Parliament Buildings Wellington, New Zealand*

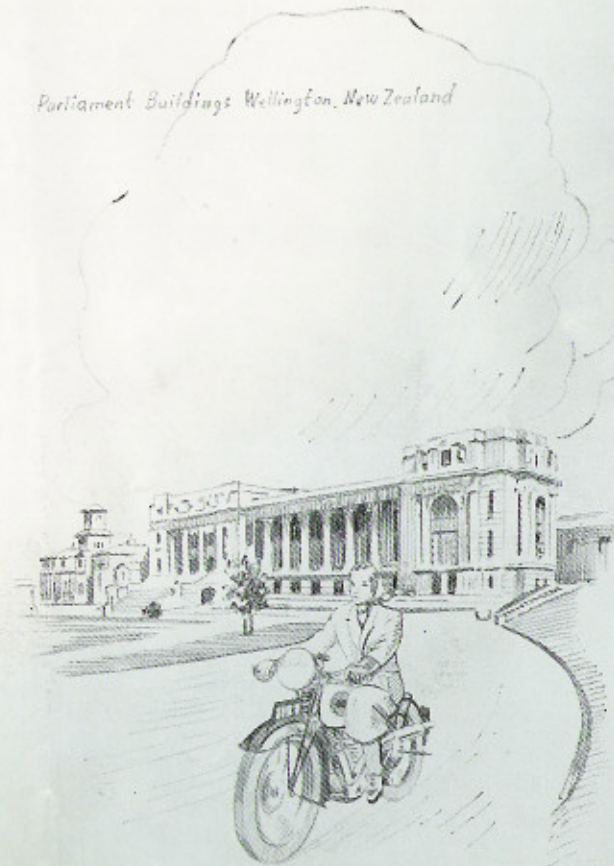



*The*  
**O.H.V. DE LUXE**  
**250 c.c. MODEL DG £48-10**

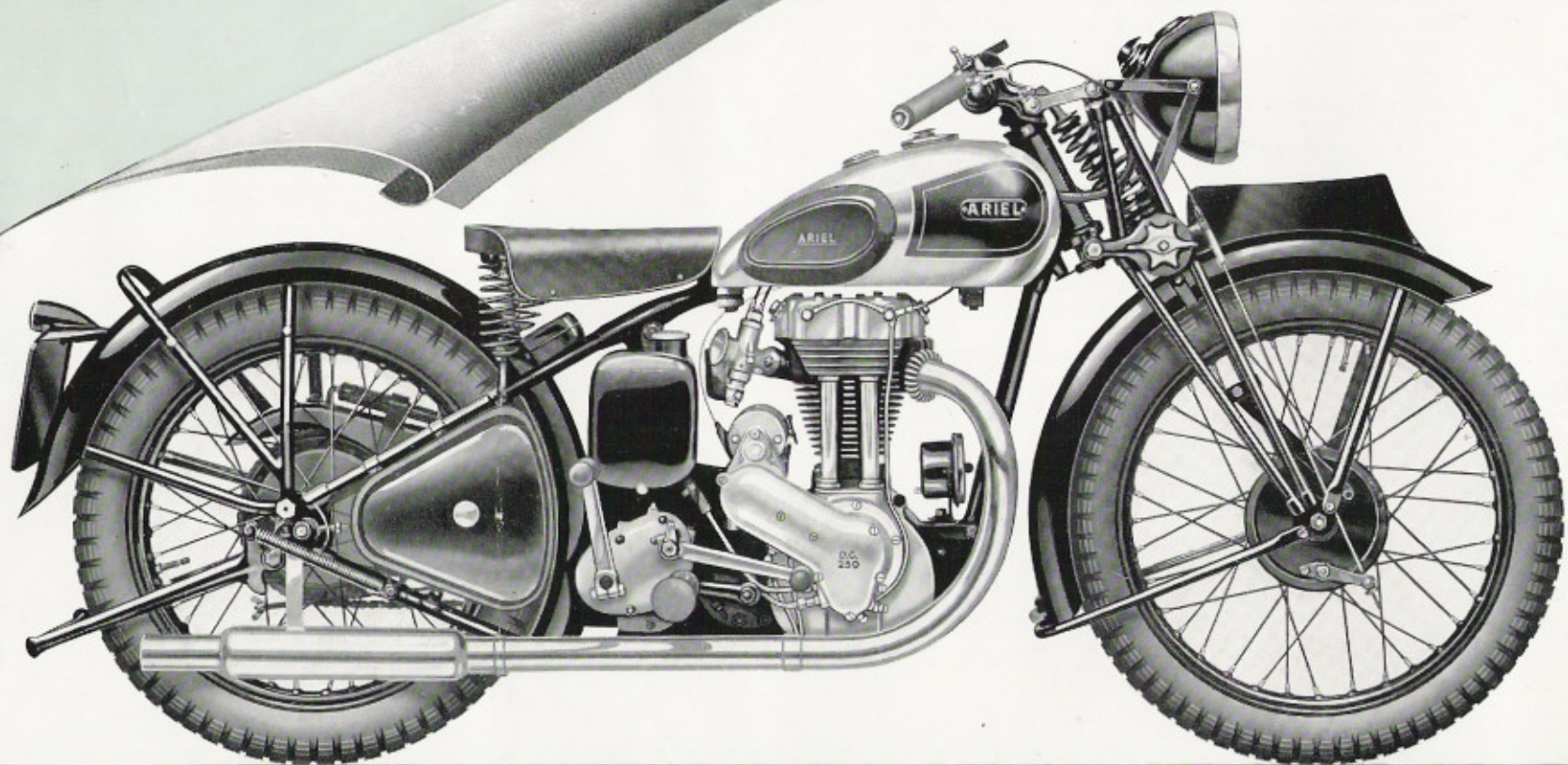



# The **O.H.V. DE LUXE 250<sub>cc</sub> MODEL OG**

**ENGINE**—61 x 85 mm. (249 c.c.) Single-port (Two-port 30/- extra). High efficiency engine. Completely enclosed valve and rocker gear automatically lubricated under pressure. Ball bearings on both sides of mainshaft. Double roller bearing big-end. High tensile steel connecting rod. Aluminium alloy piston, 6 to 1 compression.

**LUBRICATION**—Dry sump system, employing dual plunger pumps and  $\frac{1}{2}$ -gallon capacity separate oil tank. Patent oil purifier incorporated in Flywheels.

**CARBURETTER**—Down-draught Amal.

**GEARBOX**—Four-speed. Foot control. Internal clutch operating lever.

**SPEEDOMETER**—Smith 80 m.p.h. trip speedometer will be fitted at extra (see page 28) unless otherwise ordered. Fork mounted, internal front wheel drive only.

**TRANSMISSION**—Engine shaft shock absorber. Polished aluminium oil bath chain case with plug for clutch adjustment. Rear chain fully protected and automatically lubricated.

**EXHAUST SYSTEM**—Single-port with round spiral baffle silencer.

**WHEELS**—Dunlop Universal tyres 3.25 x 19 rear ; 3.00 x 20 front.

**MUDGUARDS**—Robust ribbed section steel guards, as illustrated. Tail of rear guard hinged to facilitate wheel removal.

**TANK**—All steel saddle type without instrument panel. Centrally disposed quick release filler cap and oil gauge.  $2\frac{1}{2}$ -gallon capacity. Superbly finished Chromium and Black, lined Gold.

*Parliament Buildings, Ottawa, Canada.*





*The*  
**S.V. DE LUXE**  
600 c.c. MODEL VB £60.10

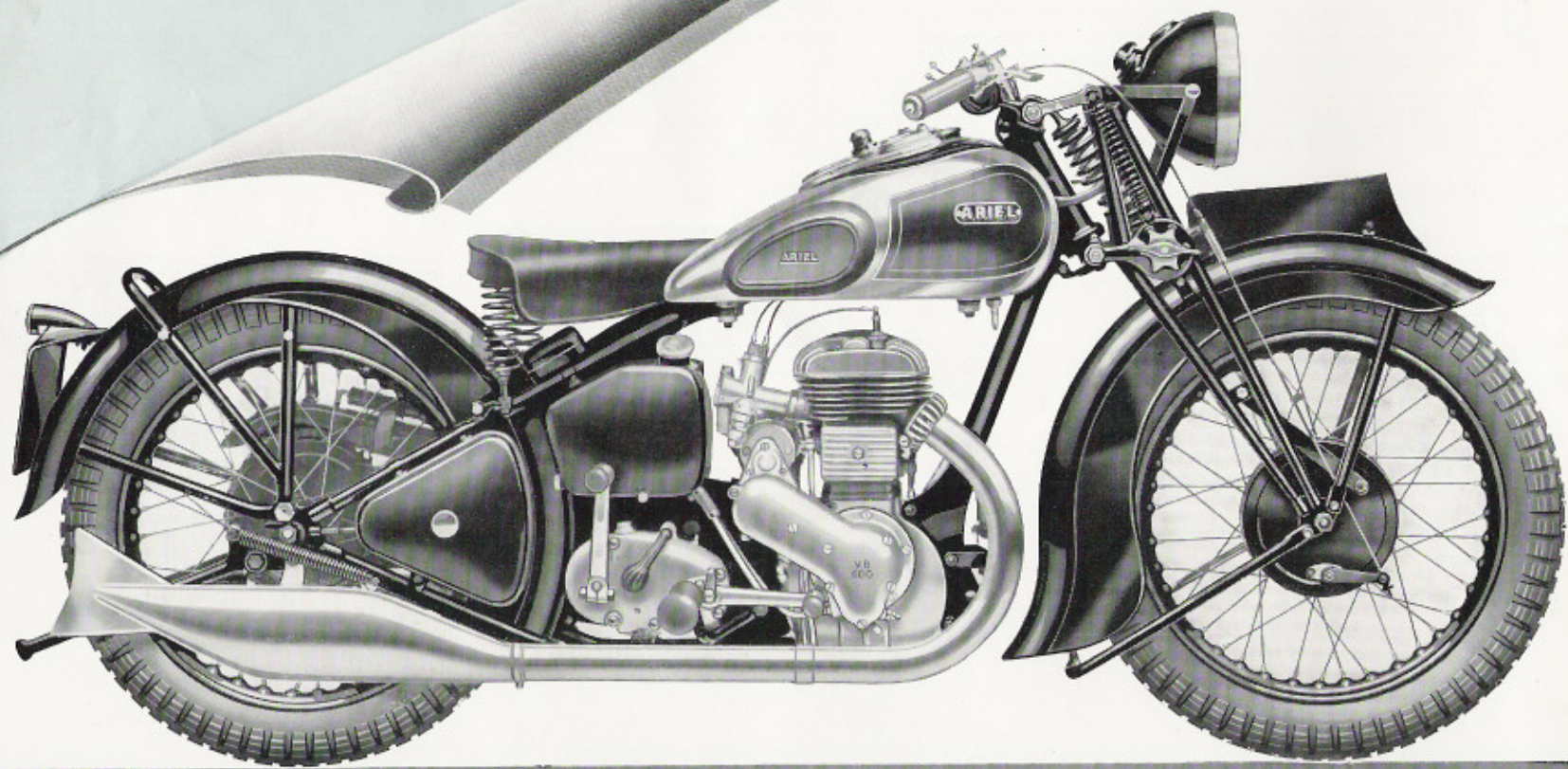



# The S.V. DE LUXE 600<sub>c.c.</sub> MODEL VB

**ENGINE**—86.4 x 102 mm. (598 c.c.). Detachable high power cylinder head. Totally enclosed valve springs. Ball bearings on both sides of mainshaft. Double roller bearing big-end. High tensile steel connecting rod. Aluminium alloy piston, 5 to 1 compression.

**LUBRICATION**—Dry sump system, employing dual plunger pumps and  $\frac{3}{4}$ -gallon capacity separate oil tank. Patent oil purifier incorporated in Flywheels.

**CARBURETTER**—Down-draught Amal.

**GEARBOX**—Four-speed. Foot control. Clutch lever enclosed in rubber moulding.

**SPEEDOMETER**—Smith 80 m.p.h. trip speedometer, tank mounted, gearbox drive, will be fitted at extra (see page 28) unless otherwise ordered. Fork mounted, internal front wheel drive optional.

**TRANSMISSION**—Engine shaft shock absorber. Polished aluminium oil bath chain case and Ariel outside clutch of large dimensions. Rear chain fully protected and automatically lubricated.

**EXHAUST SYSTEM**—Large diameter exhaust pipe, with streamlined silencer.

**WHEELS**—Dunlop Universal tyres 3.25 x 19.

**MUDGUARDS**—Robust ribbed section steel guards, fully valanced, as illustrated. Tail of rear guard hinged to facilitate wheel removal.

**TANK**—All-steel saddle type, with instrument panel.  $3\frac{1}{2}$ -gallon capacity. Superbly finished Chromium and Black, lined Gold.

*Rhodes Memorial, Capetown, South Africa*

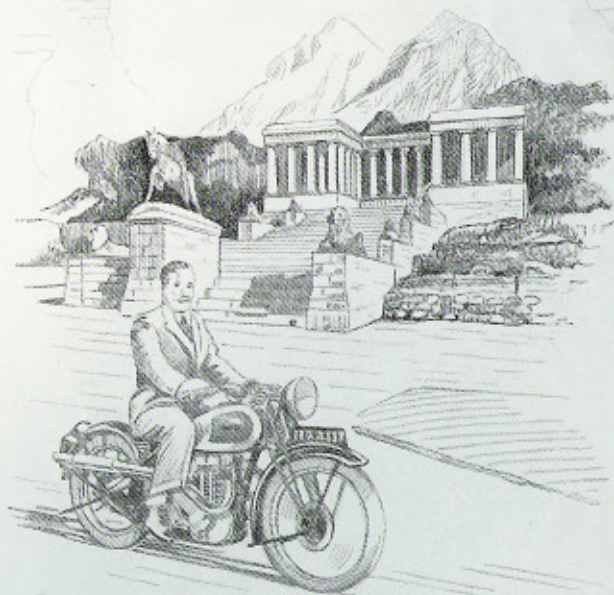



# The S.V. DE LUXE 600<sub>c.c.</sub> MODEL VB

**ENGINE**—86.4 x 102 mm. (598 c.c.). Detachable high power cylinder head. Totally enclosed valve springs. Ball bearings on both sides of mainshaft. Double roller bearing big-end. High tensile steel connecting rod. Aluminium alloy piston, 5 to 1 compression.

**LUBRICATION**—Dry sump system, employing dual plunger pumps and  $\frac{3}{4}$ -gallon capacity separate oil tank. Patent oil purifier incorporated in Flywheels.

**CARBURETTER**—Down-draught Amal.

**GEARBOX**—Four-speed. Foot control. Clutch lever enclosed in rubber moulding.

**SPEEDOMETER**—Smith 80 m.p.h. trip speedometer, tank mounted, gearbox drive, will be fitted at extra (see page 28) unless otherwise ordered. Fork mounted, internal front wheel drive optional.

**TRANSMISSION**—Engine shaft shock absorber. Polished aluminium oil bath chain case and Ariel outside clutch of large dimensions. Rear chain fully protected and automatically lubricated.

**EXHAUST SYSTEM**—Large diameter exhaust pipe, with streamlined silencer.

**WHEELS**—Dunlop Universal tyres 3.25 x 19.

**MUDGUARDS**—Robust ribbed section steel guards, fully valanced, as illustrated. Tail of rear guard hinged to facilitate wheel removal.

**TANK**—All-steel saddle type, with instrument panel.  $3\frac{1}{4}$ -gallon capacity. Superbly finished Chromium and Black, lined Gold.

*Rhodes Memorial, Capetown, South Africa*

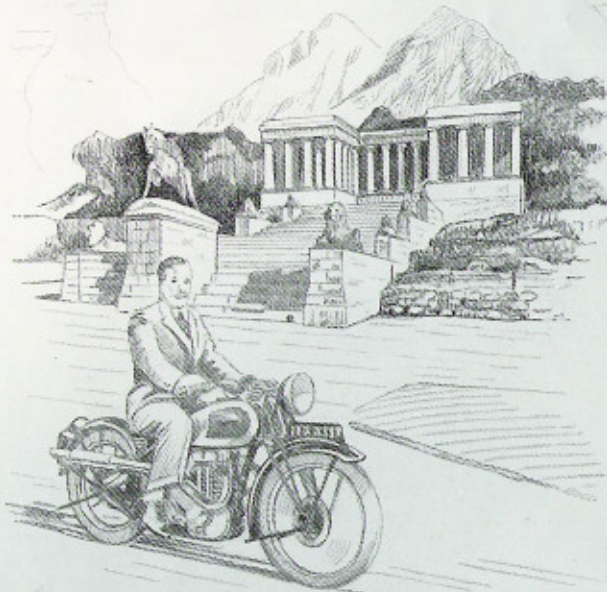



*The*  
**S.V. STANDARD**  
500c.c. MODEL VA £57.10

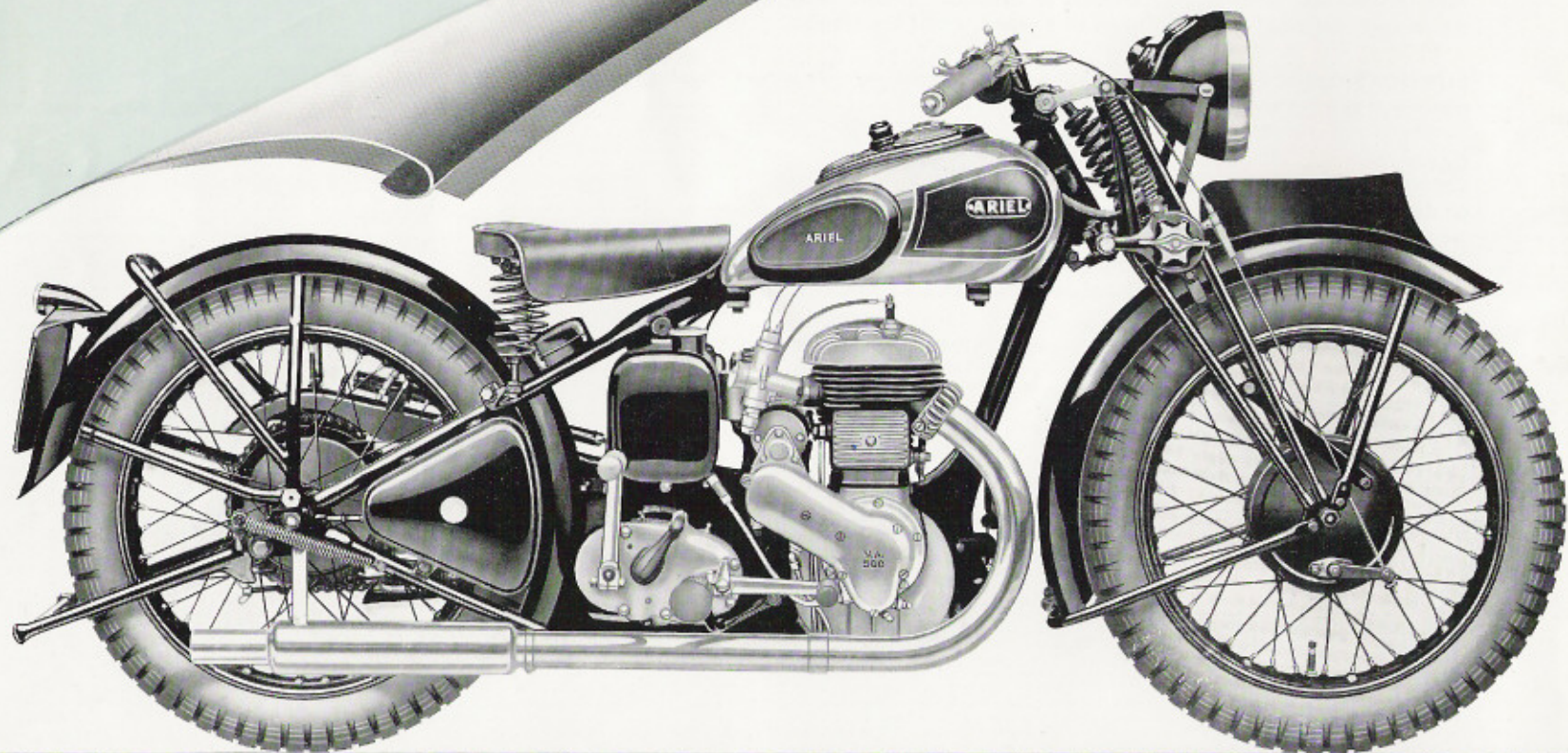



# The S.V. STANDARD 500 c.c. MODEL VA

**ENGINE**—81.8 x 95 mm. (497 c.c.). Detachable high power cylinder head. Totally enclosed valve springs. Ball bearings on both sides of mainshaft. Double roller bearing big-end. High tensile steel connecting rod. Aluminium alloy piston.

**LUBRICATION**—Dry sump system, employing dual plunger pumps and  $\frac{1}{2}$ -gallon capacity separate oil tank. Patent oil purifier incorporated in Flywheels.

**CARBURETTER**—Down-draught Amal.

**GEARBOX**—Four-speed. Foot control. Clutch lever enclosed in rubber moulding.

**SPEEDOMETER**—Smith 80 m.p.h. trip speedometer, tank mounted, gearbox drive, will be fitted at extra (see page 28) unless otherwise ordered. Fork mounted, internal front wheel drive optional.

**TRANSMISSION**—Engine shaft shock absorber. Polished aluminium oil bath chain case and Ariel outside clutch of large dimensions. Rear chain fully protected and automatically lubricated.

**EXHAUST SYSTEM**—Large diameter exhaust pipe, with spiral baffle silencer.

**WHEELS**—Dunlop Universal tyres 3.25 x 19.

**MUDGUARDS**—Robust ribbed section steel guards, as illustrated. Tail of rear guard hinged to facilitate wheel removal.

**TANK**—All steel saddle type, with instrument panel. 2 $\frac{1}{2}$ -gallon capacity. Superbly finished Chromium and Black, lined Gold.

*Tower Bridge London.*





# The **ARIEL**

PATENTED

# SPRING FRAME

(available on all models, at extra charge, except OH & OG)

## ALONE

gives all these advantages—

- Exceptional riding comfort.
- Increased stability, road holding and braking.
- Longer life of tyres, battery, etc.
- Minimum unsprung weight.
- Complete lateral rigidity.
- Constant chain tension.
- Total enclosure of working parts.

The frame is a completely brazed unit to provide maximum rigidity. Fitted through the centre of each rear fork end is a hardened guide tube A, which is clamped to the lug by a substantial bolt K. On this tube is mounted the slider B with bushes C at each end. The spring abutment collar D is forged integral with the slider and extended rearwards to form a horizontal pivot boss E, fitted with bushes F. The pin G passing through this pivot supports each side of the stirrup H, which surrounds the fork lug. The closed end of the stirrup is anchored to the chain stays by short links I, and one arm is extended to carry the wheel spindle. Renewable bushes are fitted to all bearings and the slider mechanism is completely enclosed against mud and dust by tubes L and M.

The fixing of the wheel in stirrups, which are connected by pivots at each end to the frame, prevents any lateral movement and ensures that the vertical movement of the wheel has no effect on chain tension.

page twenty-four

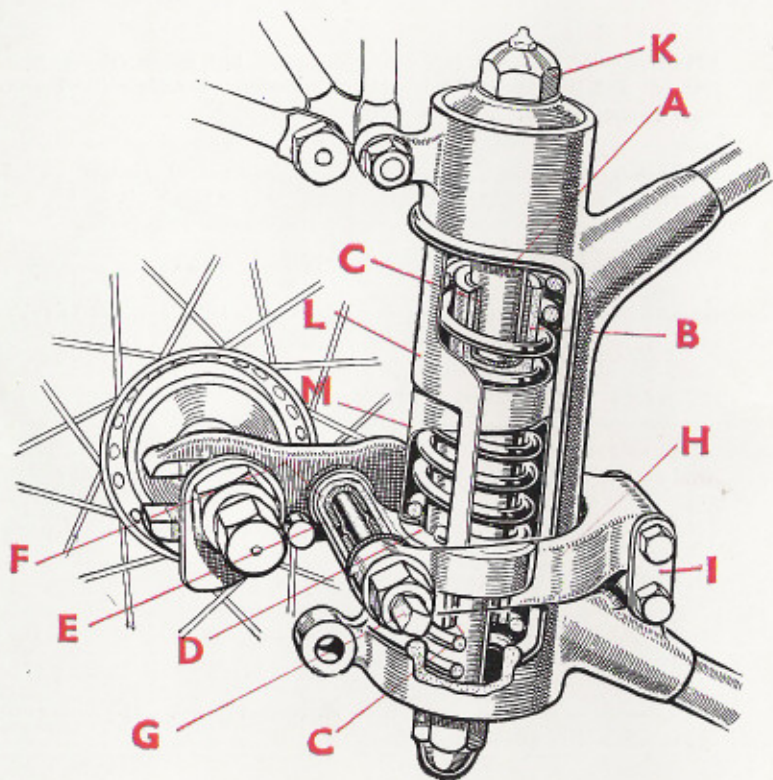

**ARIEL — LEADERS**



The  
**FAMOUS**  
**POWER UNIT**  
*of the*  
**ARIEL**  
**SQUARE**  
**FOUR**

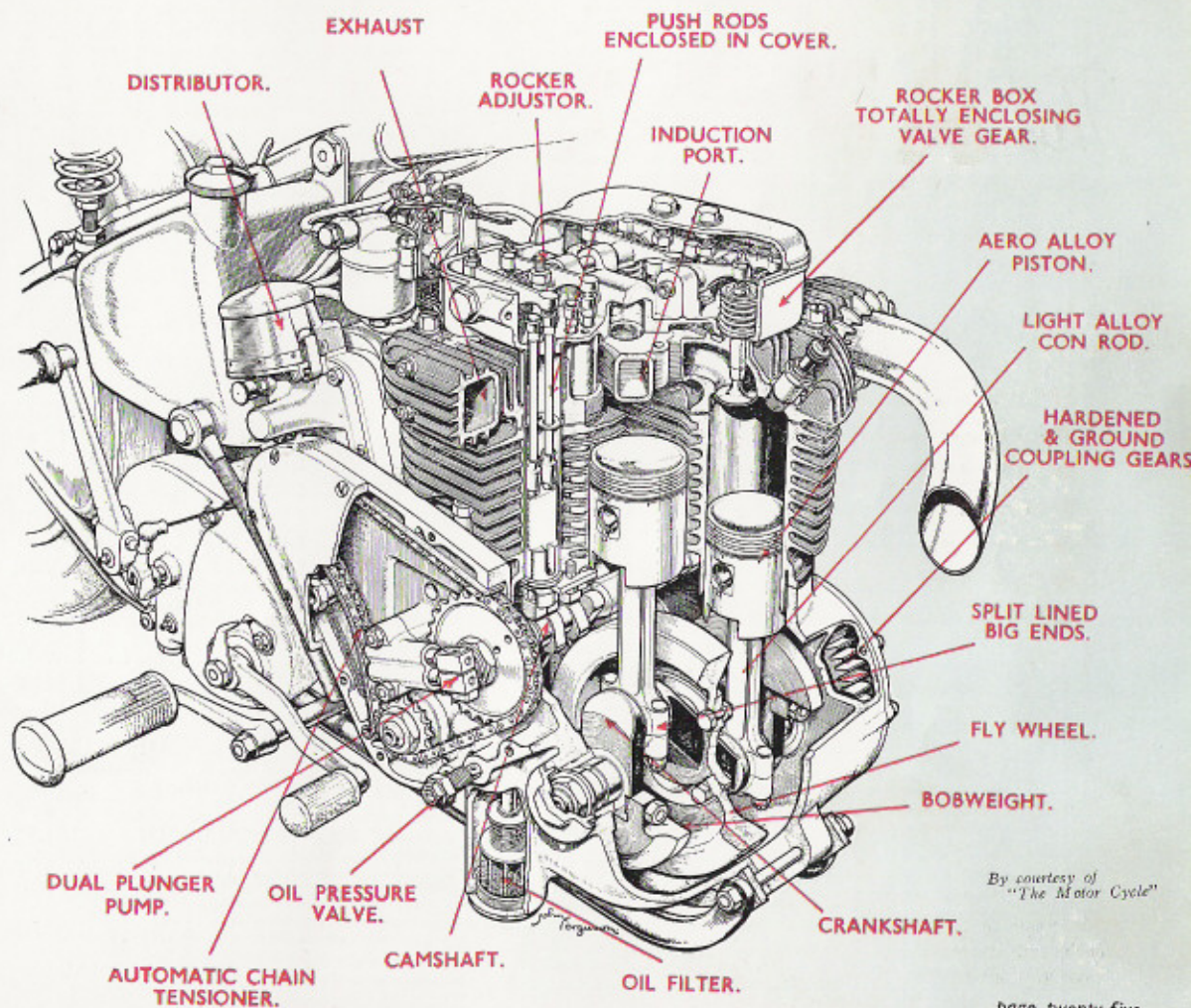

By courtesy of  
*"The Motor Cycle"*

page twenty-five



The  
**FAMOUS**  
**POWER UNIT**  
 of the  
**ARIEL**  
**SQUARE**  
**FOUR**

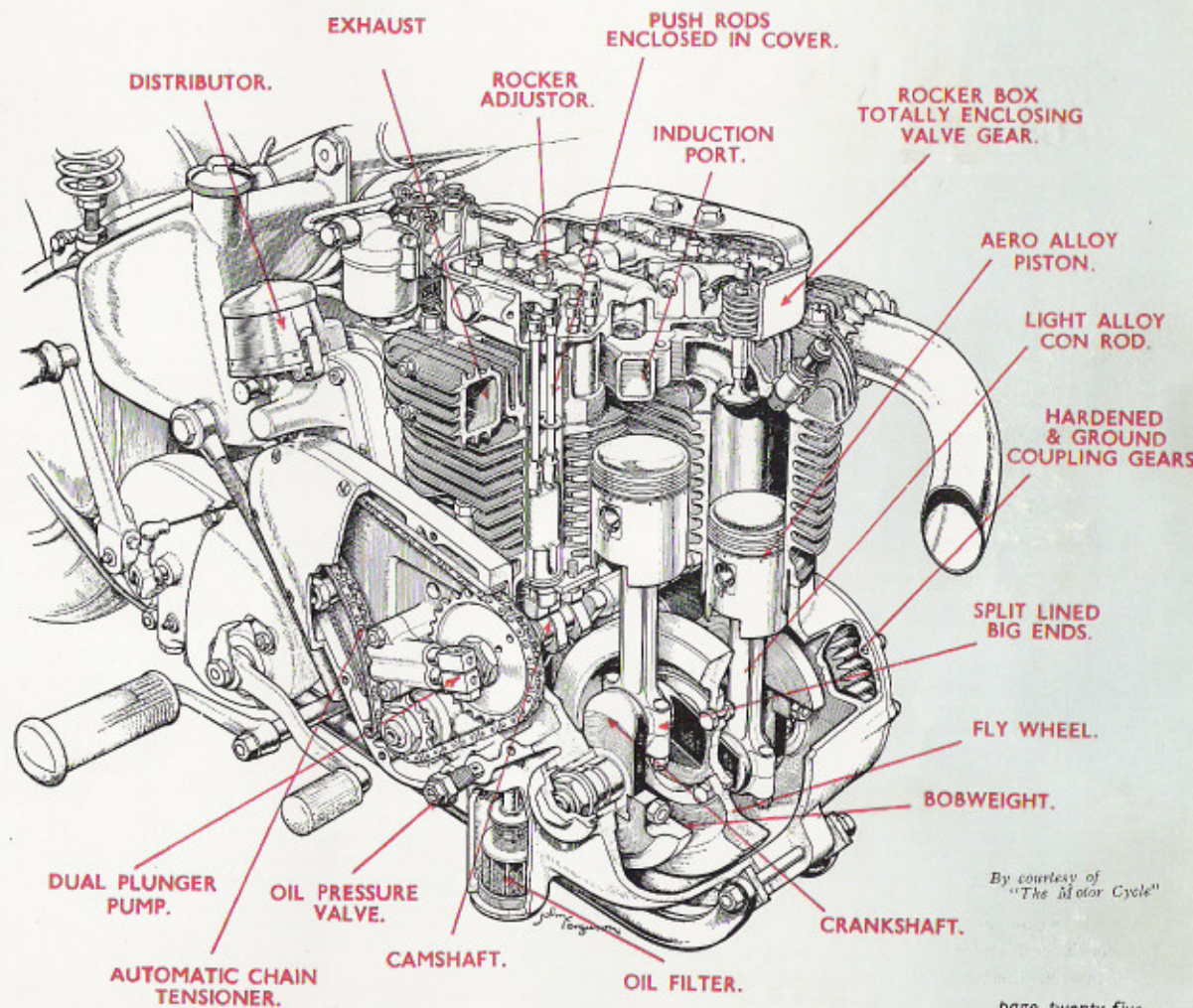

By courtesy of  
 "The Motor Cycle"

page twenty-five

OF DESIGN



# ARIEL *The world's* FINEST COMPETITION



The winner of the Scottish Six Days Trial, Fred Povey (350 Ariel) making a perfect climb of Boleskine.  
By courtesy of "Motor Cycling"

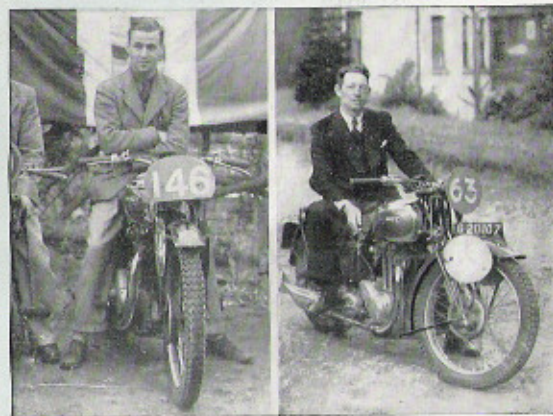

INTERNATIONAL SIX DAYS GOLD MEDAL WINNERS.  
Ariel riders, E. Fijma and A. Archer, who completed the "International" without losing a single mark.  
By courtesy of "The Motor Cycle"

## Some of last year's Successes

### SCOTTISH SIX DAYS TRIAL

Ariels scored the most magnificent success ever achieved in the history of motor cycle competitions by winning:

- MANUFACTURERS' TEAM PRIZE (SOLO).
- MANUFACTURERS' TEAM PRIZE (MIXED, i.e. 500 c.c. & 250 c.c.).
- BEST PERFORMANCE OF TRIAL (G. F. Povey).
- BEST 500 c.c. PERFORMANCE (L. Haach).
- BEST 250 c.c. PERFORMANCE (J. White).
- BEST SIDECAR OVER 350 c.c. (D. Povey & J. s.c.).
- 5 SILVER CUPS, 4 SILVER PLAQUES, 1 SILVER MEDAL.

### INTERNATIONAL SIX DAYS TRIAL

- 4 GOLD MEDALS  
(Next best British Marque 2 Gold Medals).
- 1 SILVER MEDAL
- 3 BRONZE MEDALS

#### COLMORE CUP TRIAL

- 6 First Class Awards.
- 2 Second Class Awards.
- 1 Third Class Award.

#### COTSWOLD CUPS TRIAL

- Best Sidecar Performance (H. R. Taylor, 497 Ariel, s.c.).
- Best 250 c.c. Performance (J. White, 248 Ariel).
- Manufacturers' Team Prize.
- 4 First Class Awards. 2 Second Class Awards.

#### VICTORY CUP TRIAL

- Best Sidecar Performance (W. J. Stocker, 497 Ariel s.c.).
- Perrey Cup (Best 500 c.c.) L. Haach, 497 Ariel.
- 1 First Class Award. 2 Second Class Awards.

#### KICKHAM MEMORIAL TRIAL

- Dickenson Cup. Bristol Cup.
- 4 First Class Awards.
- 4 Second Class Awards.

#### SUNBEAM CLUB SCRAMBLE

- Senior Solo Race:
  - 1st W. A. West, 497 Ariel.
  - 2nd G. A. Wolsey, 497 Ariel.
  - 3rd N. J. Wolsey, 497 Ariel.
- Sidecar Race:
  - 1st H. R. Taylor, 497 Ariel s.c.

#### PERCE SIMON TRIAL

- Best Solo Performance. (L. Haach, 497 Ariel).
- Best Sidecar Performance. (W. J. Stocker, 497 Ariel, s.c.).
- "Vale" Cup (2nd Best Solo).
- "250" Cup and Unlimited Cup.

#### AUSTRALIAN LAND SPEED RECORD

- Established by Mr. A. Senior on a 500 c.c. Red Hunter Ariel at a mean speed of 127.65 m.p.h.



# MACHINE !



Some of the Awards won by the Scottish Six Days Trialists



Len Heath (500 Ariel), Jack White (250 Ariel), Fred Povey (350 Ariel), Members of the winning Solo Team in the Scottish Six Days Trial. Each of these riders made the best performance in his class.

By courtesy of "Motor Cycling."

## Notes of Interest

Wheelbase	250 c.c. models	52in.
	All other models	54in.
Length Overall	250 c.c. models	83in.
	All other models	86in.
Ground Clearance...		4in.
Saddle Height		26in.
Width of Handlebar		30in.

### GEAR RATIOS.

	Engine Sprocket	Top	3rd	2nd	1st
<b>Square Four</b>					
1000 c.c.					
Solo	24T	4.5	5.7	7.7	12.1
Sidecar	22T	4.9	6.2	8.4	13.2
600 c.c.					
Solo	24T	5.4	6.9	9.5	14.4
Sidecar	22T	5.9	7.5	10.3	15.7
<b>Single Cylinder</b>					
500 c.c. O.H.V.,					
600 c.c. S.V.					
Solo	23T	4.7	6.0	8.0	12.6
Sidecar	19T	5.7	7.2	9.7	15.3
500 c.c. S.V.					
Solo...	23T	5.0	6.4	8.8	13.3
Sidecar	19T	6.0	7.7	10.6	16.1
350 c.c. O.H.V.					
Solo	20T	5.7	7.3	10.1	15.3
250 c.c. O.H.V.					
Solo...	19T	6.5	9.2	11.7	19.4

**OIL CONSUMPTION** will depend upon running conditions, but Single Cylinder models will normally average 2,000—2,500 m.p.g. whilst the Four Cylinder models will give 1,500—2,000 m.p.g.

**PETROL CONSUMPTION** will vary according to running speed and road conditions, etc., but under average touring conditions (solo) should be approximately as follows in miles per gallon: OG, OH, 85; NG, NH, VA, 80; YG, VB, VH, 75; 4F, 70; 4G, 4H, 60/65.



# Extras

	£	s.	d.
Spring Frame (cannot be fitted to models OH and OG) ... ..	10	0	0
Detachable Rear Wheel (where not standard) ...	2	0	0
Licence Holder ... ..	2	6	
Smith Trip Type Speedometer, 80 m.p.h. ... ..	2	10	0
Smith Trip Type Speedometer, 100 m.p.h. ... ..	2	15	0
Smith 8-day Clock ... ..	1	10	0
Dunlop Tyres, 3.25 x 19 Fort ... .. pair	15	0	
Dunlop Tyres, 3.50 x 19 ... ..	15	0	
Dunlop Tyres, 3.50 x 19 Fort ... ..	1	5	0
Dunlop Tyres, 3.00 x 21 Competition ... .. each	7	6	
Dunlop Tyres, 4.00 x 19 Competition ... ..	17	6	
Lucas Stop instead of Tail Light ... ..	9	0	
Pillion Footrests ... .. pair	7	6	
Pillion Seat ... ..	10	0	
Pillion Exhaust Pipe Leg Guards ... .. pair	7	6	
Carrier ... ..	10	0	
Front Valanced Guards (where not standard) ...	7	6	
Rear Valanced Guards (where not standard) ...	7	6	
Chromium Plated and Enamelled Centred Rims (where not standard) ... .. pair	15	0	
Special Prop Stand (where not standard)... ..	10	0	
Leg Shields ... ..	1	10	0
Crankcase Undershield ... ..	10	0	
Colonial Sidecar Handlebars... ..	10	0	

NOTE—Hand-control instead of foot-control can be fitted to special order on any model without extra charge.

All prices are subject to alteration without notice.

## DETACHABLE REAR WHEEL.

The Ariel detachable rear wheel can be removed by the aid of one spanner in less than one minute. The Brake drum and sprocket remain intact. The drive is transmitted to the wheel by twelve  $\frac{1}{8}$ in. hardened pegs. The wheel itself is mounted on two self-contained journal bearings, requiring no adjustment. Available for all models, at £2 extra (fitted as standard on model 4G). The illustration also shows the standard hinged rear guard in use.

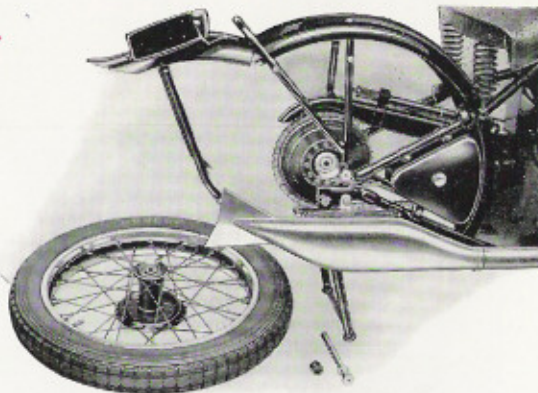

## CARRIER.

Provision is made on all Models for the ARIEL quickly detachable carrier, which can be supplied at an extra charge of 10s.

## PROP STAND

The Ariel Prop Stand, spoken of so enthusiastically by "IXION" is standardised on model 4G and can be fitted to any other model except OH and OG at an extra charge of 10s.





# Guarantee

The following Guarantee is given by all authorised Dealers in Ariel Motor Cycles and Sidecars :

"We give the following Guarantee with our Motor Cycles and Sidecars in place of and to the exclusion of any implied Conditions of Warranties or any liabilities whatsoever Statutory or otherwise :

"We guarantee that all precautions which are usual and reasonable have been taken by us to secure excellence of materials and workmanship, but this guarantee is to extend and be in force for 6 months only from date of purchase. The damages for which we make ourselves responsible under this Guarantee are limited to the free repair of or supply of a new part in exchange for the part which may have proved defective. We do not undertake to bear the cost of replacing or refixing any such new part. As Motor Cycles and Sidecars are easily liable to derangement by neglect or misuse this Guarantee does not apply to defects caused by wear and tear, neglect or misuse. We do not guarantee Tyres, Saddles, Chains, Electrical Equipment or any other Specialities of Accessory Manufacturers.

"If a defective part should be found in our Motor Cycles or Sidecars it must be sent to us carriage paid, and accompanied by an intimation from the owner that he desires to have it repaired or exchanged free of charge under our guarantee, and he must also furnish us at the same time with the number of the machine and the date of purchase."

